

### CATALOG NUMBER: E-871-W-320 FOR ONE 320 WATT, M132/M154 METAL HALIDE PULSE START LAMP

Line Voltage	120/208/240/277V
Regulation	
Line Volts	+/-10%
Line Watts	+/-10%
Frequency	60 Hz
Circuit Type	CWA
Power Factor (min)	90%
Insulation Class	H(180°)
Min. Ambient Starting Temp.	-20° F or -30° C

Line Voltage (Volts)	120	208	240	277
Line Current (Amps)				
Operating	3.24	1.90	1.62	1.40
Open Circuit	3.00	1.80	1.50	1.30
Starting	1.47	0.85	0.75	0.65
Input Watts (W)	368	368	368	368
Open Circuit Voltage (V)	270	270	270	270
Drop Out Voltage (V)	57	98	114	131
UL(1029) Bench Top Rise	A	A	A	A
Recommended Fuse (Amps)	8	6	5	3
HIGH POTENTIAL TEST (VOLTS)				
1Minute	2000			
2 Seconds	2500			
Open Circuit Voltage Test(volts)	245-295			
Short-Circuit Current Test (Amps)				
Secondary Current	3.0 - 3.6			
Input Current (Amps)				
	0.80 -	0.40 -	0.35 -	0.30 -
	1.55	0.90	0.80	0.70

#### 4 1/4" x 4 3/4" CORE

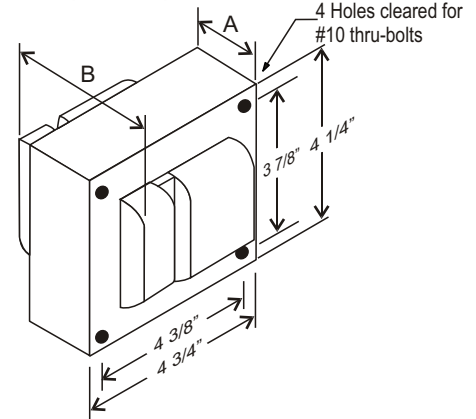

#### CORE AND COIL

Dimension A (inches)	1.80
Dimension B (inches)	3.70
Weight (Lbs)	11.80
Lead Lengths (inches)	12

#### CAPACITOR

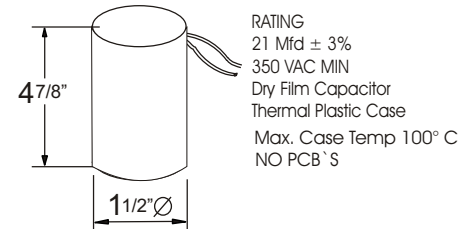

#### IGNITOR 37-63-AS-6.9-N7

Ballast to Lamp Distance (BTL): 2 feet  
(THERMAL PLASTIC CASE)  
Max. case Temp: 110° C

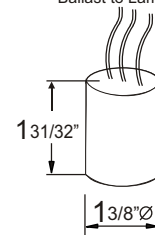

#### WIRING DIAGRAM

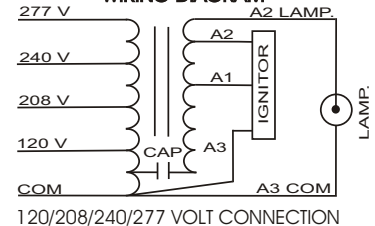

#### BRACKET

CORE & COIL  
MOUNTING BRACKET

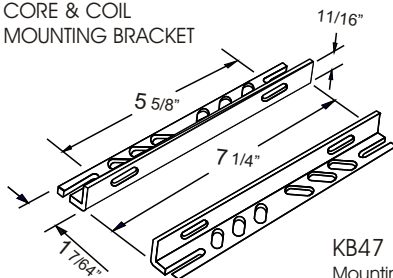

#### KB47

Mounting bracket for  
Core & Coil Ballasts  
(2 brackets with thru bolts)

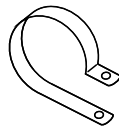

#### C-01

MOUNTING CLIP for round  
case (Furnished as standard  
with B suffix ballast)

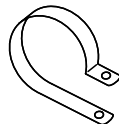

#### I-01

MOUNTING CLIP for round  
case (Furnished as standard  
with B suffix ballast)

Data is based upon tests performed by Industrias Sola Basic in a controlled environment and representative of relative performance. Actual Performance can vary depending on operating conditions. Specifications are subject to change without notice.



Certificate No. 006281



Made in Mexico by Industrias Sola Basic S.A de C.V.

## SOLA CANADA

### LIGHTING & POWER

171 Ambassador Drive  
Units 8 & 9  
Mississauga, ON  
L5T 2J1

Phone: 905-670-0746  
Fax: 905-670-9689

www.solacanada.com