

### CATALOG NUMBER: E-971-W-SO1000 FOR ONE 1000 WATT, S52 HIGH PRESSURE SODIUM LAMP

Line Voltage	120/208/240/277V
Regulation	
Line Volts	+/-10%
Line Watts	WITHIN TRAPEZOID
Frequency	60 Hz
Circuit Type	CWA
Power Factor (min)	90%
Insulation Class	H(180°)
Min. Ambient Starting Temp.	-40° F or -40° C

Line Voltage (Volts)	120	208	240	277
Line Current (Amps)				
Operating	9.5	5.5	4.8	4.1
Open Circuit	4.81	3.0	2.6	2.2
Starting	7.6	4.3	3.75	3.27
Input Watts (W)	1100	1100	1100	1100
Open Circuit Voltage (V)	435	435	435	435
Drop Out Voltage (V)	90	155	180	208
UL(1029) Bench Top Rise	D	C	D	D
Recommended Fuse (Amps)	25	15	10	10
HIGH POTENTIAL TEST (VOLTS)				
1Minute	2000			
2 Seconds	2500			
Open Circuit Voltage Test(volts)	400-475			
Short-Circuit Current Test (Amps)				
Secondary Current	6.7 - 7.5			
Input Current (Amps)	6.0 - 8.0	3.4 - 4.7	2.9 - 4.0	2.5 - 3.45

#### BRACKET

CORE & COIL  
MOUNTING BRACKET

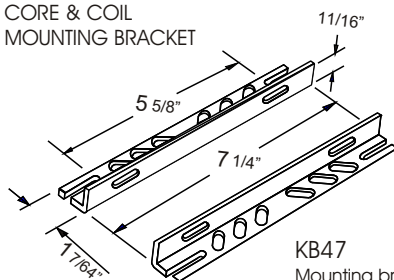

**KB47**  
Mounting bracket for  
Core & Coil Ballasts  
(2 brackets with thru bolts)

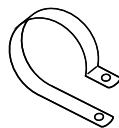

**C-01**  
MOUNTING CLIP for round  
case (Furnished as standard  
with B suffix ballast)

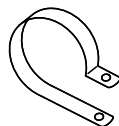

**I-01**  
MOUNTING CLIP for oval  
case (Furnished as standard  
with B suffix ballast)

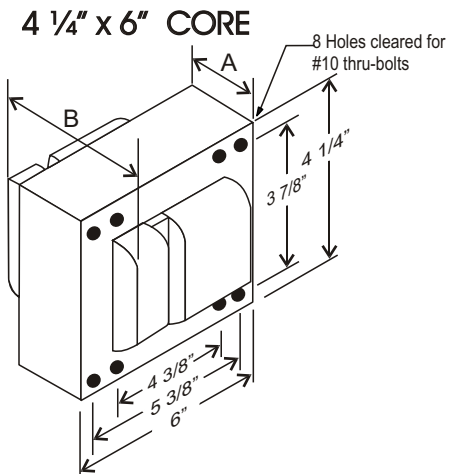

#### CORE AND COIL

Dimension A (inches)	3.81
Dimension B (inches)	6.00
Weight (Lbs)	29.00
Lead Lengths (inches)	12

#### CAPACITOR

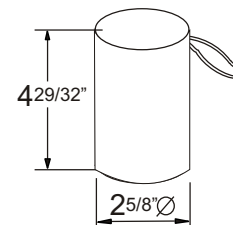

RATING  
26 Mfd ± 3%  
525 VAC MIN  
Dry Film Capacitor  
Thermal Plastic Case  
Max. Case Temp 100° C  
NO PCB'S

#### IGNITOR 37-90-AS-13.1-N1

Ballast to Lamp Distance (BTL): 2 feet

(THERMAL PLASTIC CASE)  
Max. case Temp: 110° C

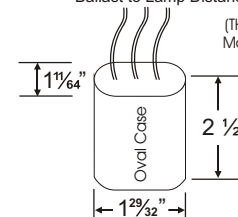

#### WIRING DIAGRAM

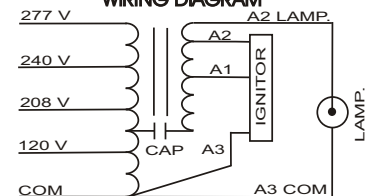

120/208/240/277 VOLT CONNECTION

Data is based upon tests performed by Industrias Sola Basic in a controlled environment and representative of relative performance. Actual Performance can vary depending on operating conditions. Specifications are subject to change without notice.



Certificate No. 006281



## SOLA CANADA LIGHTING & POWER

171 Ambassador Drive  
Units 8 & 9  
Mississauga, ON  
L5T 2J1

Phone: 905-670-0746  
Fax: 905-670-9689

www.solacanada.com