

CATALOG NUMBER: E-971-W-SO400 FOR ONE 400 WATT, S51 HIGH PRESSURE SODIUM LAMP

Line Voltage	120/208/240/277V
Regulation	
Line Volts	+/-10%
Line Watts	WITHIN TRAPEZOID
Frequency	60 Hz
Circuit Type	CWA
Power Factor (min)	90%
Insulation Class	H(180°)
Min. Ambient Starting Temp.	-40° F or -40° C

Line Voltage (Volts)	120	208	240	277
Line Current (Amps)				
Operating	3.90	2.25	1.95	1.70
Open Circuit	2.13	1.20	1.10	0.93
Starting	3.05	1.74	1.90	1.65
Input Watts (W)	464	464	464	464
Open Circuit Voltage (V)	190	190	190	190
Drop Out Voltage (V)	90	156	180	208
UL(1029) Bench Top Rise	D	D	D	D
Recommended Fuse (Amps)	10	8	5	5
HIGH POTENTIAL TEST (VOLTS)				
1Minute	2000			
2 Seconds	2500			
Open Circuit Voltage Test(volts)	170-210			
Short-Circuit Current Test (Amps)				
Secondary Current	6.2 - 7.0			
Input Current (Amps)	2.7 - 3.1	1.60 - 1.80	1.40 - 1.60	1.20 - 1.40

4 1/4" x 4 3/4" CORE

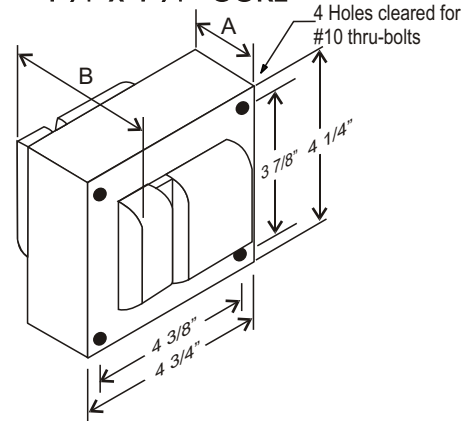

CORE AND COIL

Dimension A (inches)	2.30
Dimension B (inches)	4.00
Weight (Lbs)	14.60
Lead Lengths (inches)	12

CAPACITOR

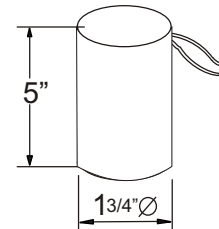

RATING
55 Mfd ± 3%
240 VAC MIN
Dry Film Capacitor
Thermal Plastic Case
Max. Case Temp 100° C
NO PCB'S

IGNITOR 37-63-AS-6.9-N6

Ballast to Lamp Distance (BTL): 2 feet

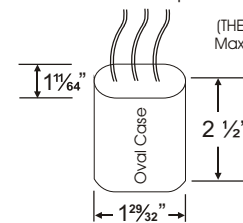

(THERMAL PLASTIC CASE)
Max. case Temp: 110° C

WIRING DIAGRAM

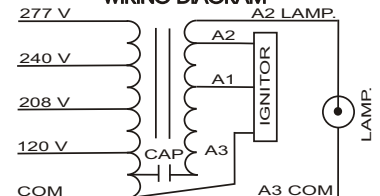

120/208/240/277 VOLT CONNECTION

BRACKET

CORE & COIL
MOUNTING BRACKET

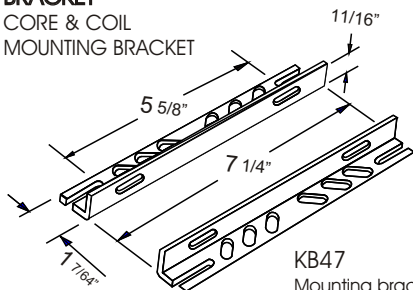

KB47
Mounting bracket for
Core & Coil Ballasts
(2 brackets with thru bolts)

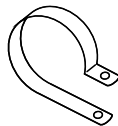

C-01
MOUNTING CLIP for round
case (Furnished as standard
with B suffix ballast)

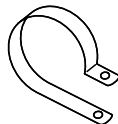

I-01
MOUNTING CLIP for oval
case (Furnished as standard
with B suffix ballast)

Data is based upon tests performed by Industrias Sola Basic in a controlled environment and representative of relative performance. Actual Performance can vary depending on operating conditions. Specifications are subject to change without notice.



Certificate No. 006281



Made in Mexico by Industrias Sola Basic S.A de C.V.

SOLA CANADA LIGHTING & POWER

171 Ambassador Drive
Units 8 & 9
Mississauga, ON
L5T 2J1

Phone: 905-670-0746
Fax: 905-670-9689

www.solacanada.com