

CATALOG NUMBER: E-MCA0DD200 FOR ONE 200 WATT, M136 METAL HALIDE PULSE START LAMP

Line Voltage	480V
Regulation	
Line Volts	+/-10%
Line Watts	+/- 10%
Frequency	60 Hz
Circuit Type	CWA
Power Factor (min)	90%
Insulation Class	H(180°)
Min. Ambient Starting Temp.	-20° F or -30° C

Line Voltage (Volts)	480
Line Current (Amps)	
Operating	0.50
Open Circuit	0.50
Starting	0.26
Input Watts (W)	232
Open Circuit Voltage (V)	270
Drop Out Voltage (V)	250
UL(1029) Bench Top Rise	C
Recommended Fuse (Amps)	2

HIGH POTENTIAL TEST (VOLTS)	
1Minute	2000
2 Seconds	2500
Open Circuit Voltage Test(volts)	250-300
Short-Circuit Current Test (Amps)	
Secondary Current	1.8 - 2.15
Input Current (Amps)	0.15 - 0.30

BRACKET CORE & COIL MOUNTING BRACKET

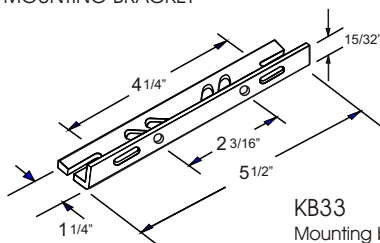

KB33
Mounting bracket for
Core & Coil Ballasts
(1 bracket with thru bolts)

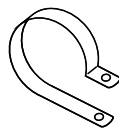

C-01
MOUNTING CLIP for round
case (Furnished as standard
with B suffix ballast)

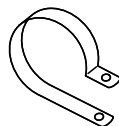

I-01
MOUNTING CLIP for oval
case (Furnished as standard
with B suffix ballast)

3" x 4" CORE

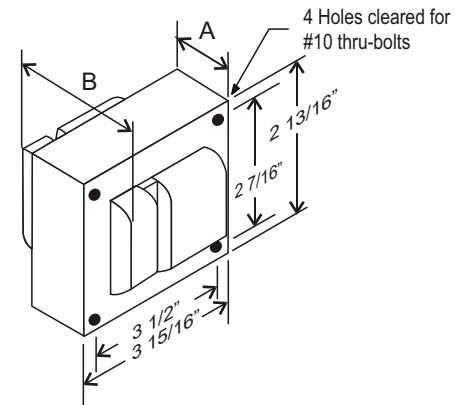

CORE AND COIL

Dimension A (inches)	2.50
Dimension B (inches)	3.80
Weight (Lbs)	8.50
Lead Lengths (inches)	12

CAPACITOR

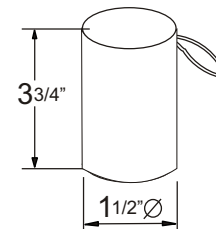

RATING
12 Mfd ± 3%
400 VAC MIN
Dry Film Capacitor
Thermal Plastic Case
Max. Case Temp 100° C
NO PCB'S

IGNITOR 356-AS-21-MH

Ballast to Lamp Distance (BTL): 2 feet

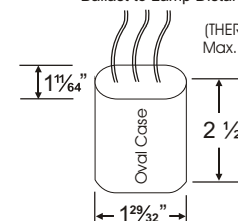

(THERMAL PLASTIC CASE)
Max. case Temp: 110° C

WIRING DIAGRAM

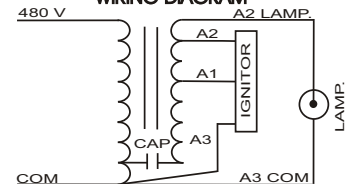

480 VOLT CONNECTION

Data is based upon tests performed by Industrias Sola Basic in a controlled environment and representative of relative performance. Actual Performance can vary depending on operating conditions. Specifications are subject to change without notice.



Certificate No. 006281



SOLA CANADA LIGHTING & POWER

171 Ambassador Drive
Units 8 & 9
Mississauga, ON
L5T 2J1

Phone: 905-670-0746
Fax: 905-670-9689

www.solacanada.com