

### CATALOG NUMBER: E-MCAFTJ401 FOR ONE 400 WATT, M135/M155 METAL HALIDE PULSE START LAMP

Line Voltage	120/277/347V
Regulation	
Line Volts	+/-10%
Line Watts	+/- 10%
Frequency	60 Hz
Circuit Type	CWA
Power Factor (min)	90%
Insulation Class	H(180°)
Min. Ambient Starting Temp.	-20° F or -30° C

Line Voltage (Volts)	120	277	347
Line Current (Amps)			
Operating	3.80	1.70	1.40
Open Circuit	3.00	1.30	1.00
Starting	2.15	0.95	0.75
Input Watts (W)	452	452	452
Open Circuit Voltage (V)	270	270	270
Drop Out Voltage (V)	60	138	175
UL(1029) Bench Top Rise	E	E	E
Recommended Fuse (Amps)	10	5	4
HIGH POTENTIAL TEST (VOLTS)			
1Minute	2000		
2 Seconds	2500		
Open Circuit Voltage Test(volts)	245-300		
Short-Circuit Current Test (Amps)			
Secondary Current	3.5 - 4.3		
Input Current (Amps)	1.62 - 2.35	0.65 - 1.05	0.55 - 0.85

#### 4 1/4" x 4 3/4" CORE

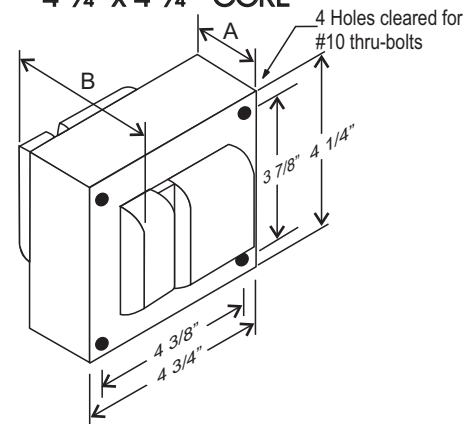

#### CORE AND COIL

Dimension A (inches)	1.80
Dimension B (inches)	3.70
Weight (Lbs)	12.25
Lead Lengths (inches)	12

#### CAPACITOR

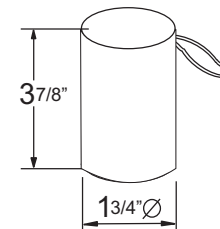

RATING  
24 Mfd ± 3%  
360 VAC MIN  
Dry Film Capacitor  
Thermal Plastic Case  
Max. Case Temp 100° C  
NO PCB'S

#### IGNITOR 37-63-AS-6.9-N7

Ballast to Lamp Distance (BTL): 2 feet

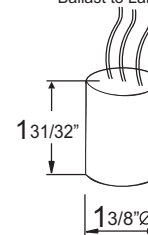

(THERMAL PLASTIC CASE)  
Max. case Temp: 110° C

#### BRACKET

CORE & COIL  
MOUNTING BRACKET

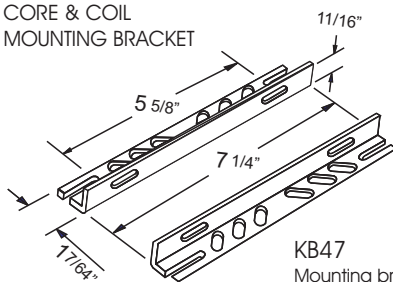

KB47  
Mounting bracket for  
Core & Coil Ballasts  
(2 brackets with thru bolts)

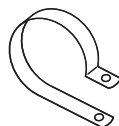

C-01  
MOUNTING CLIP for round  
case (Furnished as standard  
with B suffix ballast)

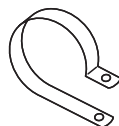

I-01  
MOUNTING CLIP for round  
case (Furnished as standard  
with B suffix ballast)

#### WIRING DIAGRAM

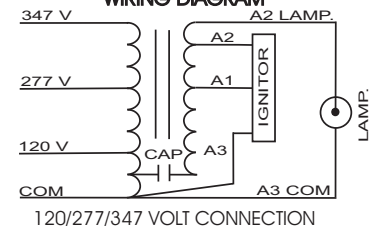

Data is based upon tests performed by Industrias Sola Basic in a controlled environment and representative of relative performance. Actual Performance can vary depending on operating conditions. Specifications are subject to change without notice.



Certificate No. 006281



## SOLA CANADA LIGHTING & POWER

171 Ambassador Drive  
Units 8 & 9  
Mississauga, ON  
L5T 2J1

Phone: 905-670-0746  
Fax: 905-670-9689

www.solacanada.com