

CATALOG NUMBER: E-MCAWDD251 FOR ONE 250 WATT, M138/M153 METAL HALIDE PULSE START LAMP

Line Voltage	120/208/240/277/480 V
Regulation	
Line Volts	+/-10%
Line Watts	+/-10%
Frequency	60 Hz
Circuit Type	CWA
Power Factor (min)	90%
Insulation Class	H(180°)
Min. Ambient Starting Temp.	-20° F or -30° C

Line Voltage (Volts)	120	208	240	277	480
Line Current (Amps)					
Operating	2.50	1.40	1.30	1.10	0.65
Open Circuit	2.0	1.20	1.0	0.90	0.50
Starting	1.55	0.90	0.80	0.68	0.40
Input Watts (W)	288	288	288	288	288
Open Circuit Voltage (V)	290	290	290	290	290
Drop Out Voltage (V)	60	104	120	140	240
UL(1029) Bench Top Rise	A	A	A	A	A
Recommended Fuse (Amps)	8	5	5	3	2
HIGH POTENTIAL TEST (VOLTS)					
1Minute	2000				
2 Seconds	2500				
Open Circuit Voltage Test(volts)	260-315				
Short-Circuit Current Test (Amps)					
Secondary Current	2.3 - 2.7				
Input Current (Amps)	1.30 - 1.65	0.75 - 0.95	0.60 - 0.80	0.50 - 0.75	0.30 - 0.40

BRACKET

CORE & COIL
MOUNTING BRACKET

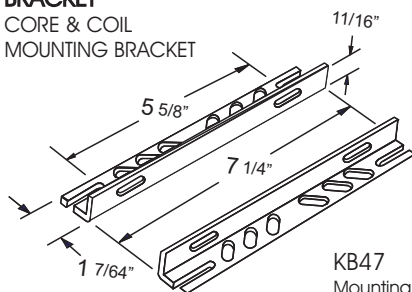

KB47
Mounting bracket for
Core & Coil Ballasts
(2 brackets with thru bolts)

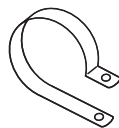

C-01
MOUNTING CLIP for round
case (Furnished as standard
with B suffix ballast)

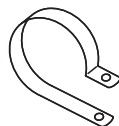

I-01
MOUNTING CLIP for round
case (Furnished as standard
with B suffix ballast)

4 1/4" x 4 3/4" CORE

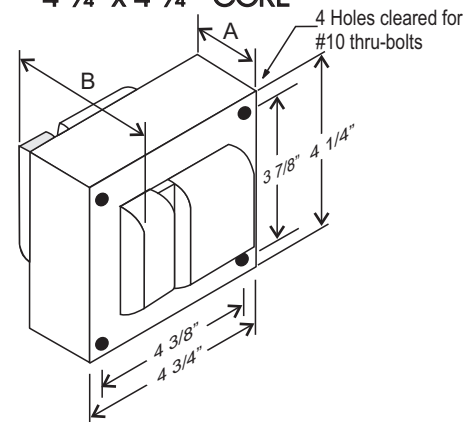

CORE AND COIL

Dimension A (inches)	1.50
Dimension B (inches)	3.40
Weight (Lbs)	11.00
Lead Lengths (inches)	12

CAPACITOR

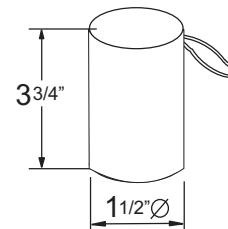

RATING
15 Mfd ± 3%
400 VAC MIN
Dry Film Capacitor
Thermal Plastic Case
Max. Case Temp 100° C
NO PCB'S

IGNITOR 37-63-AS-6.9-N7

Ballast to Lamp Distance (BTL): 2 feet

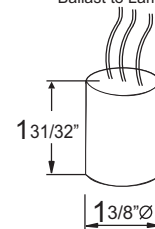

(THERMAL PLASTIC CASE)
Max. case Temp: 110° C

WIRING DIAGRAM

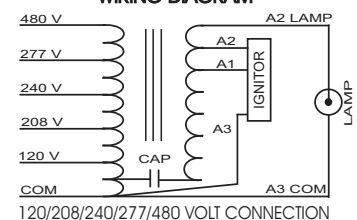

Data is based upon tests performed by Industrias Sola Basic in a controlled environment and representative of relative performance. Actual Performance can vary depending on operating conditions. Specifications are subject to change without notice.



Certificate No. 006281



SOLA CANADA

LIGHTING & POWER

171 Ambassador Drive
Units 8 & 9
Mississauga, ON
L5T 2J1

Phone: 905-670-0746
Fax: 905-670-9689

www.solacanada.com