

CATALOG NUMBER: E-MZA00W39 FOR ONE 39 WATT, M130 METAL HALIDE LAMP

Line Voltage	120/208/240/277V
Regulation	
Line Volts	+/- 5%
Lamp Watts	+/-10%
Frequency	60 Hz
Circuit Type	HX-HPF
Power Factor (min)	90%
Insulation Class	H(180°)
Min. Ambient Starting Temp.	-20° F or -30° C

Line Voltage (Volts)	120	208	240	277
Line Current (Amps)				
Operating	0.46	0.27	0.23	0.20
Open Circuit	1.02	0.60	0.51	0.45
Starting	0.35	0.20	0.17	0.15
Input Watts (W)	54	54	54	54
Open Circuit Voltage (V)	235	235	235	235
Drop Out Voltage (V)	90	150	175	208
UL(1029) Bench Top Rise	A	A	A	A
Recommended Fuse (Amps)	3	2	1	1
HIGH POTENTIAL TEST (VOLTS)				
1 Minute	2000			
2 Seconds	2500			
Open Circuit Voltage Test(volts)	205-265			
Short-Circuit Current Test (Amps)				
Secondary Current	0.6 - 0.7			
Input Current (Amps)	0.22 - 0.28	0.13 - 0.16	0.11 - 0.14	0.10 - 0.12

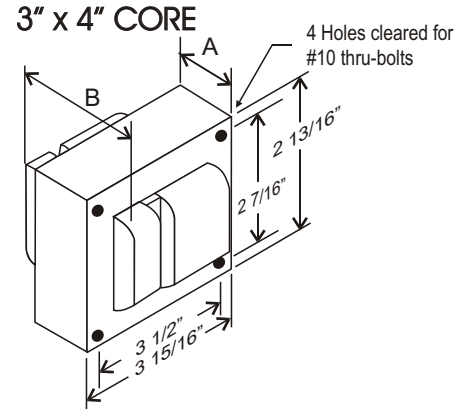

CORE AND COIL

Dimension A (inches)	1.0
Dimension B (inches)	2.3
Weight (Lbs)	4.15
Lead Lengths (inches)	12

CAPACITOR

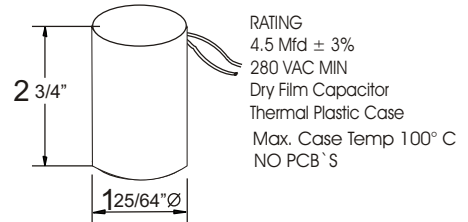

IGNITOR 356-AS-39-MH

Ballast to Lamp Distance (BTL): 5 feet

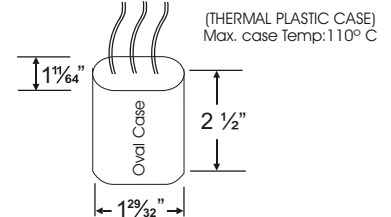

BRACKET CORE & COIL MOUNTING BRACKET

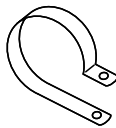
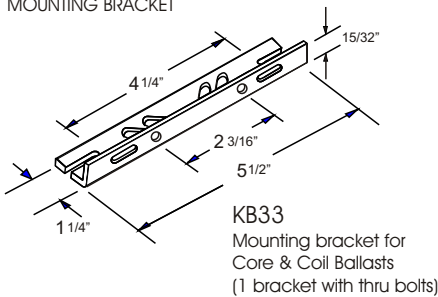

C-01
MOUNTING CLIP for round case (Furnished as standard with B suffix ballast)

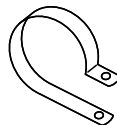

I-01
MOUNTING CLIP for oval case (Furnished as standard with B suffix ballast)

WIRING DIAGRAM

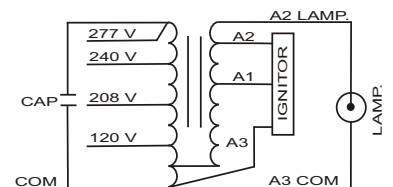

120/208/240/277 VOLT CONNECTION

Data is based upon tests performed by Industrias Sola Basic in a controlled environment and representative of relative performance. Actual Performance can vary depending on operating conditions. Specifications are subject to change without notice.

Made in Mexico by Industrias Sola Basic S.A de C.V.



SOLA CANADA

LIGHTING & POWER

171 Ambassador Drive
Units 8 & 9
Mississauga, ON
L5T 2J1

Phone: 905-670-0746
Fax: 905-670-9689

www.solacanada.com