

CATALOG NUMBER: E-SIAFRM1000 FOR ONE 1000 WATT, S52 HIGH PRESSURE SODIUM LAMP

Line Voltage	120/208/240V
Regulation	
Line Volts	+/-10%
Lamp Watts	WITHIN TRAPEZOID
Frequency	60 Hz
Circuit Type	CWI
Power Factor (min)	90%
Insulation Class	H(180°)
Min. Ambient Starting Temp.	-40° F or -40° C

Line Voltage (Volts)	120	208	240
Line Current (Amps)			
Operating	9.95	5.74	5.0
Open Circuit	6.30	3.60	3.30
Starting	4.60	2.66	2.30
Input Watts (W)	1100	1100	1100
Open Circuit Voltage (V)	420	420	420
Drop Out Voltage (V)	85	145	165
UL(1029) Bench Top Rise	D	C	C
Recommended Fuse (Amps)	25	15	15

HIGH POTENTIAL TEST (VOLTS)	
1 Minute	2000
2 Seconds	2500
Open Circuit Voltage Test (volts)	390-465

Short-Circuit Current Test (Amps)			
Secondary Current	6.2 - 6.9		
Input Current (Amps)	2.60 - 4.22	1.52 - 2.44	1.21 - 2.07

4 1/4" x 6" CORE

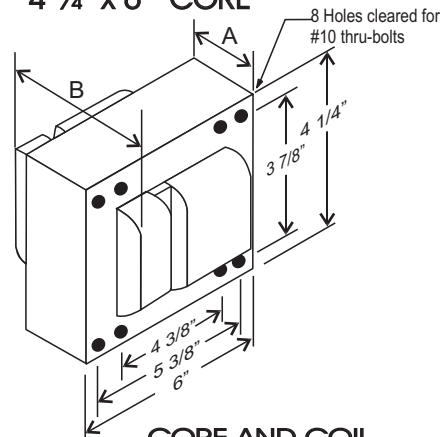

CORE AND COIL

Dimension A (inches)	5.60
Dimension B (inches)	7.60
Weight (Lbs)	45.0
Lead Lengths (inches)	12

CAPACITOR

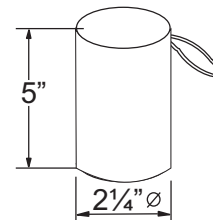

RATING
21 Mfd ± 3%
625 VAC MIN
Dry Film Capacitor
Thermal Plastic Case
Max. Case Temp 100° C
NO PCB'S

IGNITOR 37-90-AS-13.1-N1

Ballast to Lamp Distance (BTL): 50 feet

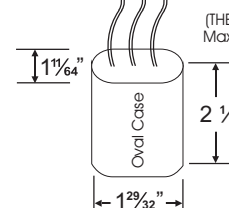

(THERMAL PLASTIC CASE)
Max. case Temp: 110° C

BRACKET CORE & COIL MOUNTING BRACKET

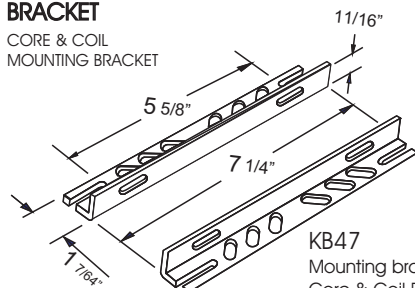

KB47
Mounting bracket for
Core & Coil Ballasts
(2 brackets with thru bolts)

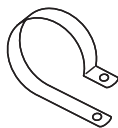

C-01
MOUNTING CLIP for round
case (Furnished as standard
with B suffix ballast)

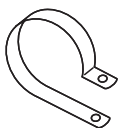

C-01
MOUNTING CLIP for oval
case (Furnished as standard
with B suffix ballast)

WIRING DIAGRAM

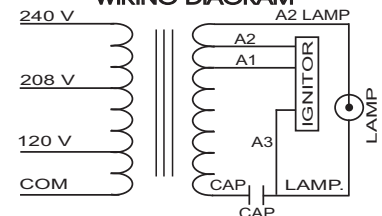

120/208/240 VOLT CONNECTION

Data is based upon tests performed by Industrias Sola Basic in a controlled environment and representative of relative performance. Actual Performance can vary depending on operating conditions. Specifications are subject to change without notice.

ISO 9001:2000



SOLA CANADA LIGHTING & POWER

171 Ambassador Drive
Units 8 & 9
Mississauga, ON
L5T 2J1

Phone: 905-670-0746
Fax: 905-670-9689

www.solacanada.com

Made in Mexico by Industrias Sola Basic S.A de C.V.