

CATALOG NUMBER: E-SIAFRM200 FOR ONE 200 WATT, S66 HIGH PRESSURE SODIUM LAMP

Line Voltage	120/208/240V
Regulation	
Line Volts	+/- 10%
Lamp Watts	WITHIN TRAPEZOID
Frequency	60 Hz
Circuit Type	CWI
Power Factor (min)	90%
Insulation Class	H(180°)
Min. Ambient Starting Temp.	-40° F or -40° C

Line Voltage (Volts)	120	208	240
Line Current (Amps)			
Operating	2.20	1.27	1.10
Open Circuit	1.26	0.73	0.65
Starting	1.06	0.62	0.54
Input Watts (W)	240	240	240
Open Circuit Voltage (V)	195	195	195
Drop Out Voltage (V)	80	140	160
UL(1029) Bench Top Rise	F	B	A
Recommended Fuse (Amps)	7	4	4
HIGH POTENTIAL TEST (VOLTS)			
1 Minute	2000		
2 Seconds	2500		
Open Circuit Voltage Test(volts)	180-215		
Short-Circuit Current Test (Amps)			
Secondary Current	2.9 - 3.3		
Input Current (Amps)		0.65 - 0.95	0.38 - 0.54
			0.33 - 0.46

4 1/4" x 4 3/4" CORE

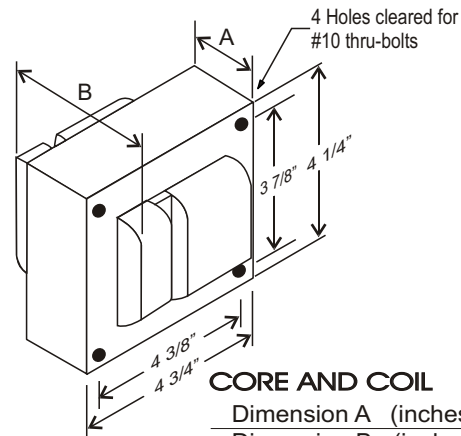

CORE AND COIL

Dimension A (inches)	1.50
Dimension B (inches)	3.20
Weight (Lbs)	11.2
Lead Lengths (inches)	12

CAPACITOR

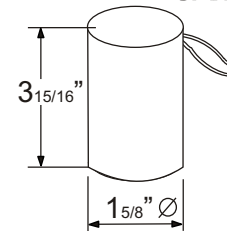

RATING
22 Mfd ± 3%
300 VAC MIN
Dry Film Capacitor
Thermal Plastic Case
Max. Case Temp 100° C
NO PCB'S

IGNITOR: 37-63-AS-6.9-N6

Ballast to Lamp Distance (BTL): 2 feet

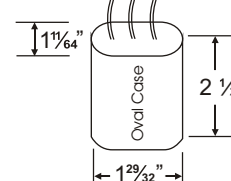

(THERMAL PLASTIC CASE)
Max. case Temp: 110° C

BRACKET

CORE & COIL
MOUNTING BRACKET

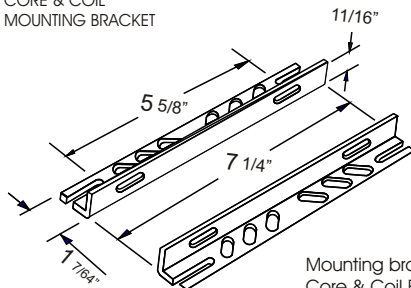

Mounting bracket for
Core & Coil Ballasts
(2 brackets with thru bolts)

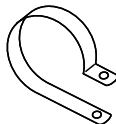

C-01

MOUNTING CLIP for round case (Furnished as standard with B suffix ballast)

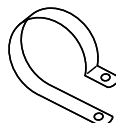

I-01

MOUNTING CLIP for oval case (Furnished as standard with B suffix ballast)

WIRING DIAGRAM

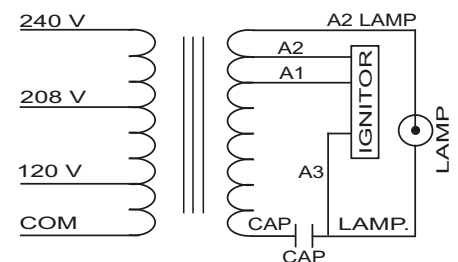

120/208/240 VOLT CONNECTION

Data is based upon tests performed by Industrias Sola Basic in a controlled environment and representative of relative performance. Actual Performance can vary depending on operating conditions. Specifications are subject to change without notice.



SOLA CANADA LIGHTING & POWER

171 Ambassador Drive
Units 8 & 9
Mississauga, ON
L5T 2J1

Phone: 905-670-0746
Fax: 905-670-9689

www.solacanada.com

Made in Mexico by Industrias Sola Basic S.A de C.V.