

### CATALOG NUMBER: E-SIAJDDZ1000 FOR ONE 1000 WATT, S52 HIGH PRESSURE SODIUM LAMP

Line Voltage	347/480/600V
Regulation	
Line Volts	+/-10%
Lamp Watts	WITHIN TRAPEZOID
Frequency	60 Hz
Circuit Type	CWI
Power Factor (min)	90%
Insulation Class	H(180°)
Min. Ambient Starting Temp.	-40° F or -40° C

Line Voltage (Volts)	347	480	600
Line Current (Amps)			
Operating	3.46	2.50	2.0
Open Circuit	2.83	1.82	1.52
Starting	1.85	1.16	1.10
Input Watts (W)	1100	1100	1100
Open Circuit Voltage (V)	420	420	420
Drop Out Voltage (V)	240	340	430
UL(1029) Bench Top Rise	E	B	B
Recommended Fuse (Amps)	10	8	6
HIGH POTENTIAL TEST (VOLTS)			
1 Minute	2200		
2 Seconds	2650		
Open Circuit Voltage Test(volts)	395-470		
Short-Circuit Current Test (Amps)			
Secondary Current	6.2 - 6.9		
Input Current (Amps)		0.86 - 0.74 - 0.57 -	
		1.50 1.13 0.90	

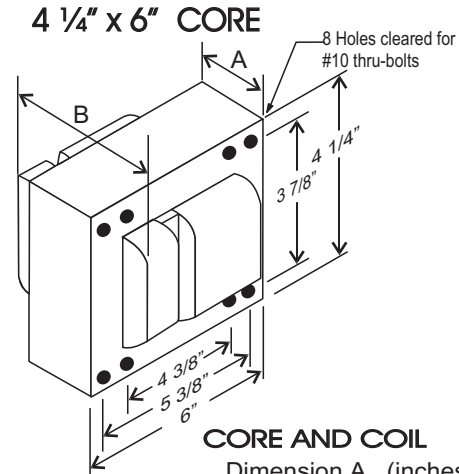

#### CORE AND COIL

Dimension A (inches)	5.60
Dimension B (inches)	7.50
Weight (Lbs)	41
Lead Lengths (inches)	12

#### CAPACITOR

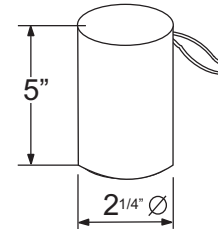

RATING  
21 Mfd ± 3%  
625 VAC MIN  
Dry Film Capacitor  
Thermal Plastic Case  
Max. Case Temp 100° C  
NO PCB'S

#### IGNITOR: 37-90-AS-13.1-N1

Ballast to Lamp Distance (BTL): 50 feet

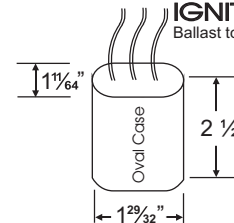

(THERMAL PLASTIC CASE)  
Max. case Temp: 110° C

#### BRACKET

CORE & COIL  
MOUNTING BRACKET

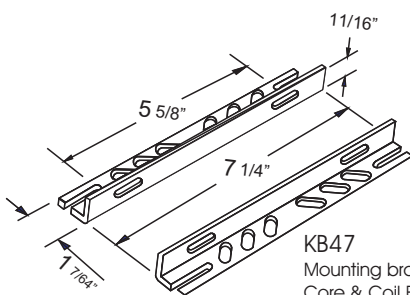

KB47  
Mounting bracket for  
Core & Coil Ballasts  
(2 brackets with thru bolts)

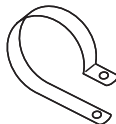

#### C-01

MOUNTING CLIP for round case (Furnished as standard with B suffix ballast)

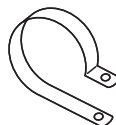

#### I-01

MOUNTING CLIP for oval case (Furnished as standard with B suffix ballast)

#### WIRING DIAGRAM

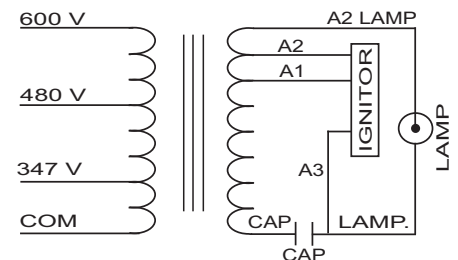

347/480/600 VOLT CONNECTION

Data is based upon tests performed by Industrias Sola Basic in a controlled environment and representative of relative performance. Actual Performance can vary depending on operating conditions. Specifications are subject to change without notice.

ISO 9001:2000



## SOLA CANADA

### LIGHTING & POWER

171 Ambassador Drive  
Units 8 & 9  
Mississauga, ON  
L5T 2J1

Phone: 905-670-0746  
Fax: 905-670-9689

www.solacanada.com

Made in Mexico by Industrias Sola Basic S.A de C.V.