

CATALOG NUMBER: E-SZA0FT35F FOR ONE 35 WATT, S76 HIGH PRESSURE SODIUM LAMP

Line Voltage	120/277V
Regulation	
Line Volts	+/- 5%
Line Watts	WITHIN TRAPEZOID
Frequency	60 Hz
Circuit Type	HX-HPF
Power Factor (min)	90%
Insulation Class	A(105°)
Min. Ambient Starting Temp.	-40° F or -40° C

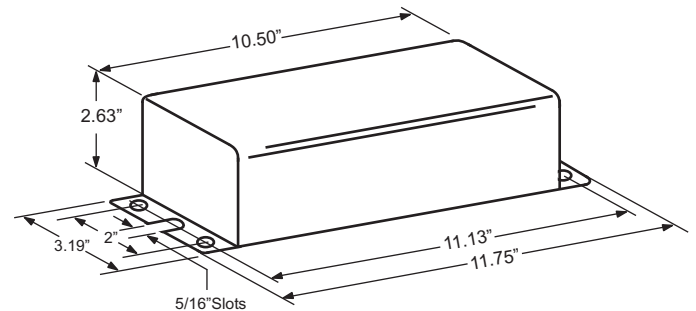

Line Voltage (Volts)	120	277
Line Current (Amps)		
Operating	0.41	0.18
Open Circuit	0.80	0.35
Starting	0.41	0.18
Input Watts (W)	47	47
Open Circuit Voltage (V)	120	120
Drop Out Voltage (V)	95	220
UL(1029) Bench Top Rise	A	A
Recommended Fuse (Amps)	3	1
HIGH POTENTIAL TEST (VOLTS)		
1 Minute	2000	
2 Seconds	2500	
Open Circuit Voltage Test(volts)	110-130	
Short-Circuit Current Test (Amps)		
Secondary Current	1.0 - 1.2	
Input Current (Amps)	0.35 -	0.30 -
	0.45	0.40

Weight (Lbs)	9.00
Lead lengths (Inches)	12.00
Sound rating	B

WIRING DIAGRAM

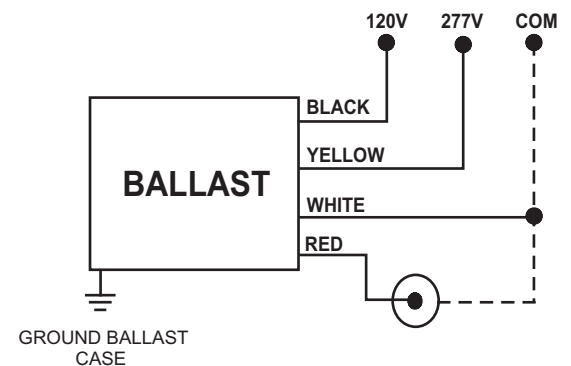

120/277 VOLT CONNECTION

IGNITOR: IN CAN

The ignitor is included as part of the potted assembly. Ballast to Lamp distance (BTL)= 15 feet. Temp. Rating: 90° C

Data is based upon tests performed by Industrias Sola Basic in a controlled environment and representative of relative performance. Actual Performance can vary depending on operating conditions. Specifications are subject to change without notice.



Certificate No. 006281



Made in Mexico by Industrias Sola Basic S.A de C.V.

SOLA CANADA

LIGHTING & POWER

171 Ambassador Drive
Units 8 & 9
Mississauga, ON
L5T 2J1

Phone: 905-670-0746
Fax: 905-670-9689

www.solacanada.com