

### CATALOG NUMBER: E-SZAFTJ50 FOR ONE 50 WATT, S68 HIGH PRESSURE SODIUM LAMP

Line Voltage	120/277/347V
Regulation	
Line Volts	+/- 5%
Lamp Watts	+/-10%
Frequency	60 Hz
Circuit Type	HX-HPF
Power Factor (min)	90%
Insulation Class	H(180°)
Min. Ambient Starting Temp.	-40° F or -40° C

Line Voltage (Volts)	120	277	347
Line Current (Amps)			
Operating	0.60	0.26	0.21
Open Circuit	1.05	0.40	0.36
Starting	0.74	0.32	0.26
Input Watts (W)	68	68	68
Open Circuit Voltage (V)	120	120	120
Drop Out Voltage (V)	96	222	278
UL(1029) Bench Top Rise	B	B	B
Recommended Fuse (Amps)	3	1	1
<b>HIGH POTENTIAL TEST (VOLTS)</b>			
1 Minute	2000		
2 Seconds	2500		
Open Circuit Voltage Test(volts)	115-135		
Short-Circuit Current Test (Amps)			
Secondary Current	1.3-1.7		
Input Current (Amps)	0.50 - 0.65	0.21 - 0.30	0.17 - 0.24

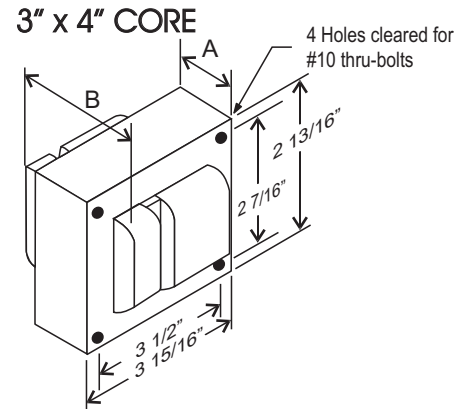

<b>CORE AND COIL</b>	
Dimension A (inches)	1.00
Dimension B (inches)	2.20
Weight (Lbs)	5.00
Lead Lengths (inches)	12

#### CAPACITOR

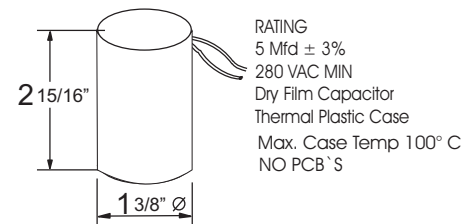

#### IGNITOR 37-63-AS-9.1-N7

Ballast to Lamp Distance (BTL): 2 feet

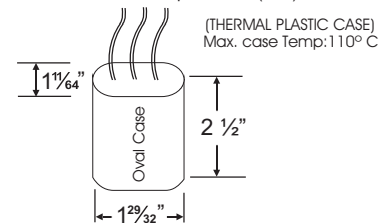

#### BRACKET CORE & COIL MOUNTING BRACKET

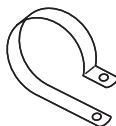
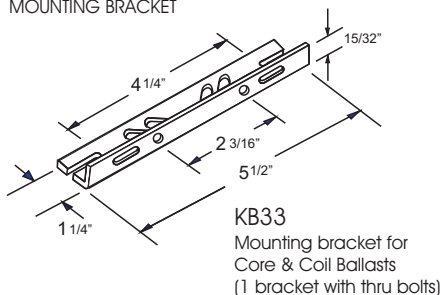

C-01  
MOUNTING CLIP for round  
case (Furnished as standard  
with B suffix ballast)

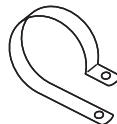

I-01  
MOUNTING CLIP for oval  
case (Furnished as standard  
with B suffix ballast)

#### WIRING DIAGRAM

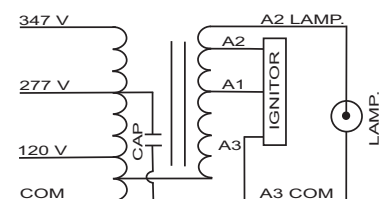

120/277/347 VOLT CONNECTION

Data is based upon tests performed by Industrias Sola Basic in a controlled environment and representative of relative performance. Actual Performance can vary depending on operating conditions. Specifications are subject to change without notice.

ISO 9001:2000



## SOLA CANADA

### LIGHTING & POWER

171 Ambassador Drive  
Units 8 & 9  
Mississauga, ON  
L5T 2J1

Phone: 905-670-0746  
Fax: 905-670-9689

www.solacanada.com

Made in Mexico by Industrias Sola Basic S.A de C.V.